



INSTRUCTIONS

C06

CD Player



Dangerous Voltage

The lightning flash with arrowhead symbol, within an equilateral triangle, is intended to alert the user to presence of uninsulated "Dangerous voltage" within the product's enclosure that may be of sufficient magnitude to constitute a risk of electric shock to persons.



Important Instructions

The exclamation point within an equilateral triangle is intended to alert the user to presence of important operating and maintenance (servicing) instructions in the literature accompanying the appliance.

Caution!!!

To reduce the risk of electrical shock, DO NOT remove cover. No user-serviceable parts inside. Refer servicing to qualified personnel.

CAUTION: This unit has no waterproof function. To avoid the risk of electric shock or fire, do not expose it to rain or moist, do not be close to the vessel with water also.

CAUTION: Rated voltage and current are different in different countries, please make sure that the label near the AC receptacle of the CD player indicates correct AC operating voltage for your location.

CAUTION: Unplug the power cord when it will not be used for a long time.



Marking by the "CE" symbol (shown left) indicates compliance of this device with the EMS (Electromagnetic Compatibility) and LVD (low voltage directive) standards of the European Community.

CAUTION: There is Class 1 laser Diode inside. Do not remove the cover or attempt to touch the inside. NEVER attempt to repair this product. If a problem occurs, contact your XINDAK dealer. This caution marks on the rear panel of the Unit.

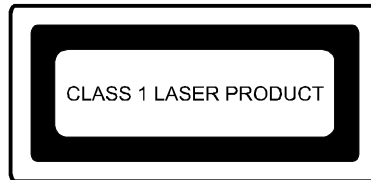

Please read all instructions and precautions carefully and completely before operating your C06 CD-Player. Then, please keep this manual for referring in future. Recommend this unit only for family using.

1.1 Before Use

Please read all instructions and precautions carefully and completely before operating your C06 CD Player.

1. Read these instructions.
2. Keep these instructions.
3. Heed all warnings.
4. Follow all instructions.
5. Do not use this apparatus near water.
6. Clean only with dry cloth.
7. Always keep this unit out of the reach of children.
8. Do not install near any heat sources such as radiators, heat registers, stoves, or other apparatus (including amplifiers) that produce heat.
9. Protect the power cord from being walked on or pinched particularly at plugs, convenience receptacles, and the point where they exit from the apparatus.
10. Unplug this apparatus during lightning storms or when unused for a long time.
11. Always disconnect your entire system from the AC mains before connecting or disconnecting any cable, or when cleaning any component.
12. This product must be terminated with a three conductor AC mains power cord which includes an earth ground connection, to prevent shock hazard, all three connections must always be used.
13. AC extension cords are not recommended for use with this product.
14. Never use flammable or combustible chemicals for cleaning audio components.
15. Never operate this product with any cover removed.
16. Never pour or spill liquids directly onto this unit.
17. Never block air flow through ventilation slots or heat sinks.
18. Never bypass any fuse.
19. Never replace any fuse with a value or type other than those specified.
20. Never attempt to repair this product, if a problem occurs, contact your dealer.
21. Never expose this product to extremely high or low temperatures.
22. Never operate this product in an explosive atmosphere.

1.2 Check Accessory

Unpack your C06 CD Player and keep all packing materials for future transport or service, locate and remove all accessory items from the accessory box within the controller shipping carton.

Accessories Included:

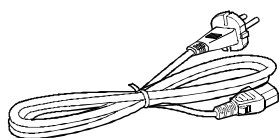

1. AC power cord × 1

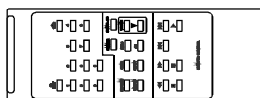

2. Remote controller × 1



3. User manual (This manual)

2.1 Precaution In Use

Installation

Select a location which is level, dry and neither too cold nor too hot, between 5°C (41 °F)and 35°C (95 °F). Avoid a dusty location or a location subject to vibrations.

Power

When unplugging from the wall outlet, always pull on the plug, not on the power cord.

Malfunctions, etc.

Do not insert any metallic object into the player.

The discs to be played on this player are limited to those bearing the mark below (Fig.1).

Placing anything other than a compact disc on the tray may cause the player to malfunction.

If something goes wrong, turn the power off immediately. If the same phenomenon occurs when the power is turned on again, turn the power off and consult your XINDAK dealer.

Volume setting

As a compact disc causes almost no noise, it is difficult to set the volume level by listening to noise as in the case of an ordinary analog turntable or a tape deck. If the volume level is raised too much because the beginning of the selection is quiet, the speakers may be damaged by a sudden increase in the sound level.

2.2 Condensation

As the compact disc player uses optical parts, moving it from a cold to warm place or using it in a room subject to excessive humidity or in a room where a fire has just been lit may cause condensation on the optical parts. This phenomenon may prevent the light from being correctly transmitted, and may cause noise or malfunction.

If dew condenses and the player does not function correctly, leave it on for several hours with the power turned on.

If the player does not function even after such period, consult your dealer.

Note:

When this unit is placed near a tuner or a receiver noise may occur. If this happens, move this unit as far from the tuner or the receiver as possible, or briefly turn off the power of the unit.



Fig.1

2.3 Compact Discs

This player can play back the CD-RW (Re-Writable) discs as well as ordinary Audio CD and CD-R (Recordable) discs.

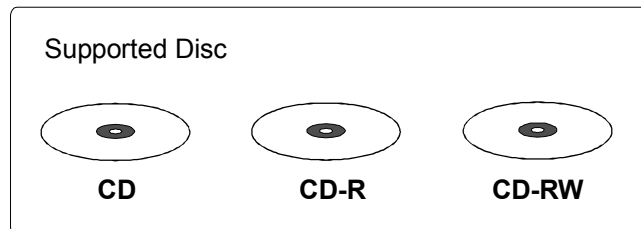

Since compact disc are made of plastic, they can be easily damaged; if the disc gets dirty, dusty, damaged or warped, the sound will not be picked up correctly, and such disc may cause the player to malfunction. When handing compact disc, use the following precautions.

Do not touch the surface of the disc (reflective silver i.e the side without the label), when handing the disc.

Storage

Make sure to keep disc in their cases. If disc are piled on top of one another without cases, they can be damaged. Do not put disc in a location exposed to direct sunlight or in a place with high temperature and humidity. Avoid leaving disc in your car.

Maintenance of disc

When fingerprints and dirt adhere to a disc, wipe the disc off with a soft, dry cloth form the inside towards the outside. If it is difficult to clean, wipe the disc with a cloth moistened with water.

Do not use record cleaners, benzene, alcohol or antistatic agent.

Do not damage the label side or stick paper or adhesive to the surface.

In the case or an 8cm(3") single CD, place it in the disc hold, for an 8 cm (3") disc, within the tray.

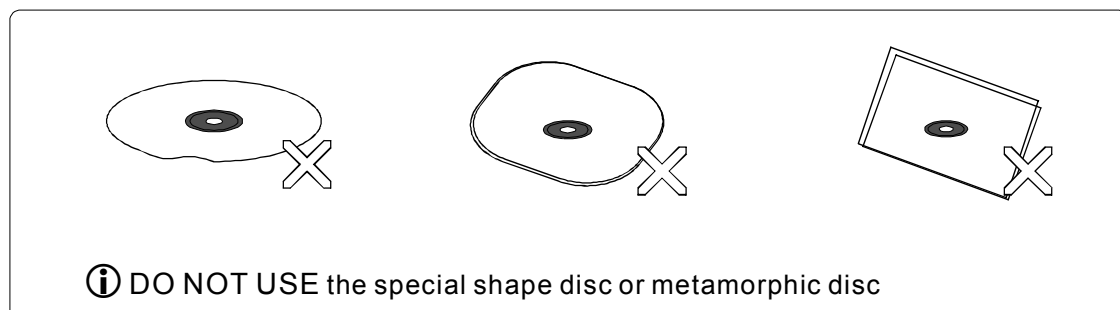

Please do not play the CD which is not round, otherwise it may cause fault on this player.

2.4 For Using the Remote Controller

Install Batteries

Before using the remote controller for the first time, you need install the new battery in the remote controller.

Process

1. Use the tool to remove the rear cover of the remote control unit.
2. Install the 2 batteries (AAA) with correct +/- polarity.
3. Reinstall the rear cover of the remote control unit.

Battery Replacement

1. Use the tool remove the rear cover of the remote control unit.
2. Take out the old batteries from remote control unit.
3. Install the 2 batteries (AAA) with correct +/- polarity.
4. Reinstall the rear cover of the remote control unit.

Caution

1. Do not use new and old batteries simultaneously.
2. Batteries with similar shapes may have different rated voltages. Be sure to use the correct batteries.
3. Remove batteries from the remote control unit if it will not be used for a long period of time.

Using Remote Controller

If you use the remote control unit to control the amplifier:

1. The remote control range is approximately 5 meters.
2. Pointing the remote control on an angle to the receiver, will shorten the useful distance of the remote control.

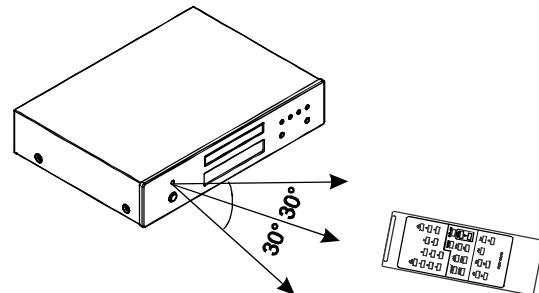
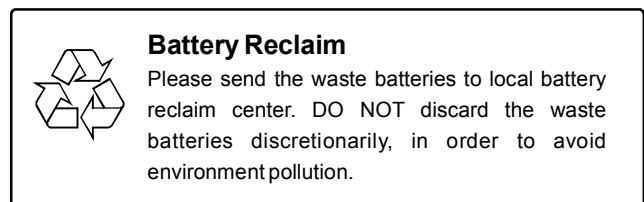
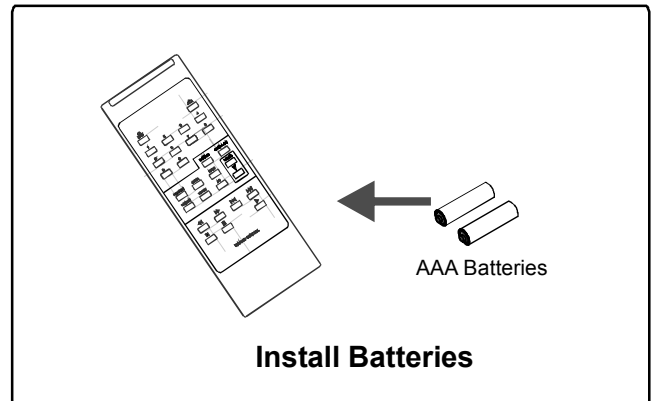



Incorrect use of batteries may cause corrosion or damage.
The lower temperature, then shorter battery life.

2.5 Remote Controller

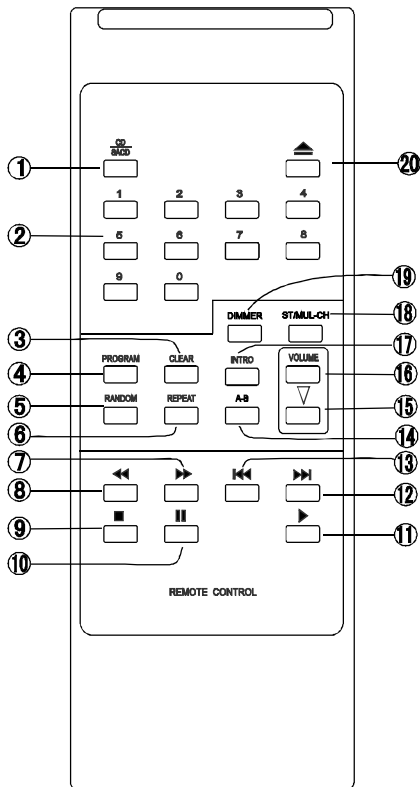

1.SACD/CD switch:
No use for this unit

2. Number Select
Press the number button 1 to 9 to choose the corresponding song to play. Press two number buttons within 2 seconds to choose the track number more than 9. For example, press 1 and 2 within 2 seconds, it will skip to No.12 song and play it. If the number chose exceeds the number range of disc, this chose will be recognized useless and the player will remain the current work model.

3.Clear/Cancel
Cancel the function operation.

4.Program Play (Chapter 3.3)

5. Random Play (Chapter 3.6).

6. Repeat play (Chapter 3.4)

7. Search Forward

When button is pressed during play, the CD player will begin to scan forward with the speed 4 times of the normal speed. When the button is kept to pressed for 4 seconds or longer, the CD player will begin to scan forward with 8 times speed of normal. Then release the pressure, the unit will resume normal play.

8. Search Backward

When button is pressed during play, the CD player will begin to scan backward with the speed 4 times of the normal speed. When the button is kept to pressed for 4 seconds or longer, the CD player will begin to scan backward with 8 times speed of normal. Then release the pressure, the unit will resume normal play.

9.Stop Play

Press button to stop play.

10. Pause Play

Press button to stop play temporarily.

11.Play

Press button to start play.

12. Skip Forward

Press button, the CD player will skip to the beginning of the next track.

13. Previous Track

Press button, the CD player will skip to the beginning of the previous track.

14. Repeat A to B (Chapter 4.4)

15. 16. Volume Control : No use for this unit

17. Preview Play

Press this button to begin the track intro scan (10 seconds). The player will play the first 10 seconds of every track. Press the button 'Clear' to cancel this operation.

18. Switch the channel: No use for this unit

19. DIMMER

Press this button to adjust the lightness of alphanumeric display window as the order: High-lightness, mid-lightness, low-lightness, close.

19. Open/Close

Press button to open or close to slide the disc tray out or in.

2.6 Front Panel

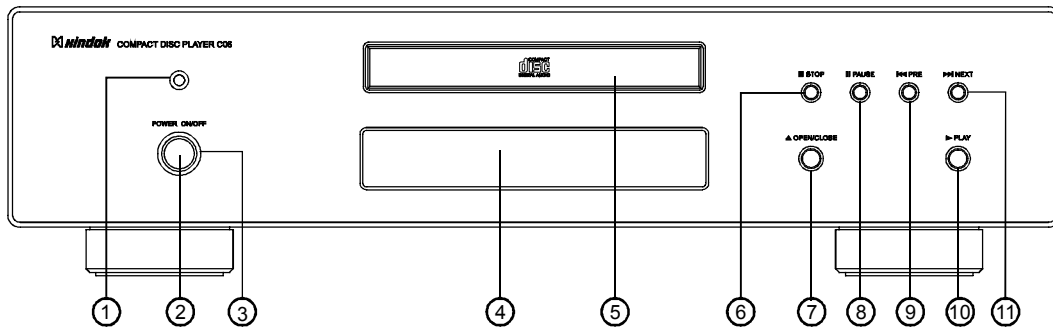

1. IR Sensor

Aiming the remote control to this window can operate this unit.

2. Power Switch

Press this button to turn on or turn off the power.

3. Power Indicator

This indicator will be light when this unit is switched on.

4. Alphanumeric Display

Display all kinds of system information.

5. DISC Tray

Handle the disc from that. Place the disc into the tray with the face with label upper.

6. STOP

Press this button to stop play.

7. OPEN/CLOSE

Press the button to remove the disc .

8. PAUSE

Press the button to stop play temporarily.

9. PRE

Press this button, the CD player will skip to the beginning of the previous track

10. PLAY

Press this button to start play.

Press this button during play, the player will replay from the first track.

11. NEXT

Press this button, during play, to skip to the beginning of the previous song Keep pressing this button to scan backward quickly.

2.7 Rear Panel

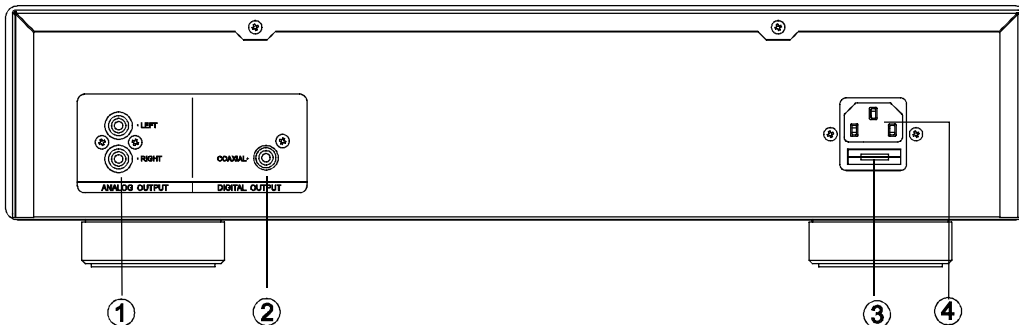

1. Audio Output Terminal

Output the analog stereo audio signal amplified by tube to the input port on the amplifier.

2. Digital Coaxial Output Terminal

By connecting this jack with digital coaxial cable to output the digital signal to the DAC or receiver.

3. Fuse Socket

Use to install the fuse.

4. AC input socket

Connect the power cord to the AC inlet.

3.1 The Connection

The CD player has two audio output models: digital signal output and analog signal output.

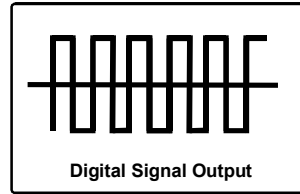
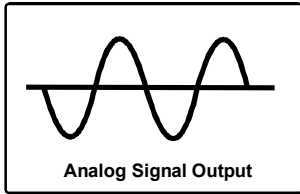

The Connection of Analog Output

You can choose the better connection model considering your audio system.

1. Coaxial Audio Output

Please use coaxial signal cable to connect the coaxial output port of this unit and make sure the reliability and correctness of the connection.

The Connection of Digital Output





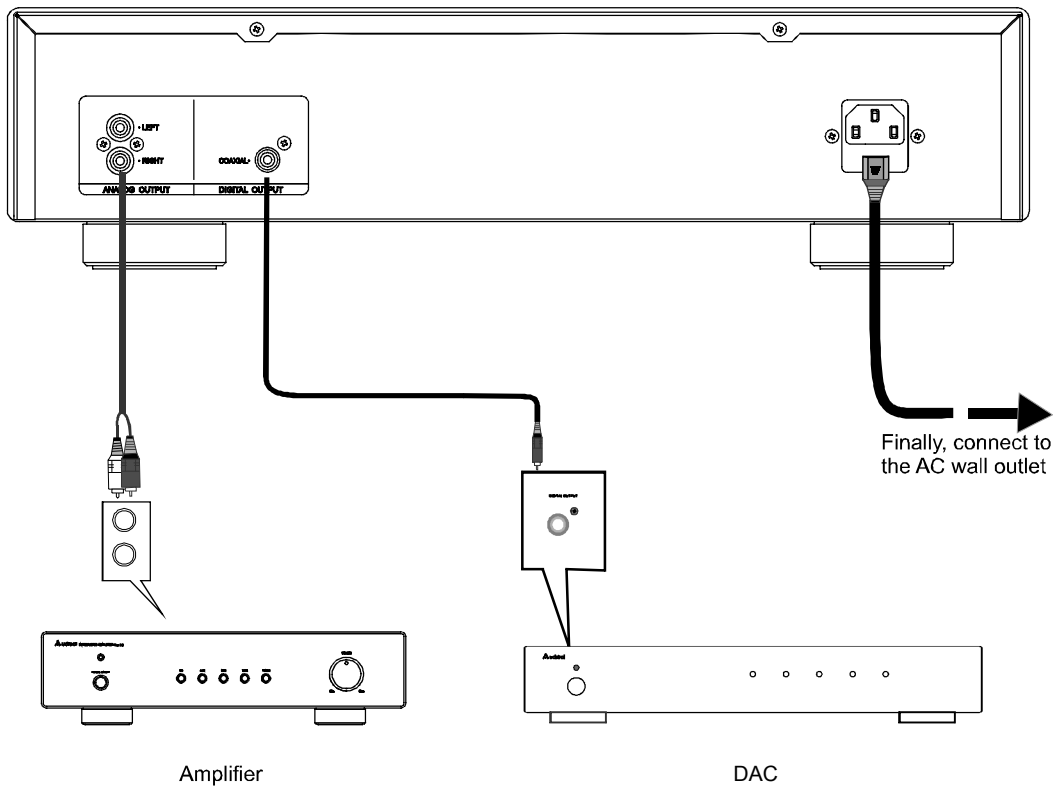

You can use anyone of coaxial to enjoy the digital audio.

1. The digital coaxial output model transfers the signal through cable by electric model. Connect the digital coaxial jack in this unit to D/A convertor by coaxial cable.



3.2 Start Play

Before enjoying the music, please confirm that the connection has been ready as the previous chapter indicated. After that, you can begin to enjoy the music.

1. Turn on the CD player. After about 30 seconds for warm-up, then press the  button to slide the disc tray out, and load a disc on the disc tray. Press the  button again to slide the disc tray in. And the display will show the number and total playing time. The player is ready to play.
2. Press the  button to start playing with the first track. Press this button during playing, the player will skip to the beginning of the current track and play it.
3. Press the  button to stop play temporarily. Press it again or press the  button, the player will continue to play.
4. Press the  button to stop play.

3.3 Program Play

To play the disc as the order you edited



1. Press the button 'PROGRAM' on the remote control during stop to enter the program play model. The display will glisteningly show "PROG".
2. Press the button skip forward/backward or directly press the number buttons to enter the track number you want. Then press the button 'PROGRAM' to store. The display will show "02 00".
3. Repeat the operation 2 to continue editing the track order.
4. After the edit finished, press the button  to play as the order you edited.
5. Press the button 'CLEAR' to cancel the program play.

3.4 Repeat Play

To repeat the track you chose

1. Repeat all/one selections

Press the button 'REPEAT' during playing, the player will switch round among following three models:

Repeat one selection (display "") → Repeat all selection (display "ALL ") → Cancel the repeat



2. Repeat A to B

Press this button during play to mark the A point, then the display "A". Press this button again to mark the end-point (repeat within 3 seconds is invalid), then the display shows "AB". The player will skip to the A point and repeat playing A to B. Press this button again, repeat will be canceled.

3. Starting repeat, the sign for repeat " " will light.
4. Press the button 'Clear' to cancel the repeat.

3.5 Preview Play

To start the track intro scan (10 seconds). The player will play the first 10 seconds of every track.

1. Press the 'INTRO' button during stop, then the information window will show 'XX int XX'. The player begins to preview the first track.
2. Press the 'INTRO' button during play, then the information window will show 'XX int XX'. The player begins to preview the next track.
3. Press the skip forward/backward button **⏮** or directly enter the number of track you want, and the player will intro scan.
4. Press the button 'Clear' to cancel this operation.

3.6 Random Play

To random play all of the tracks in disc.

1. Press the 'RANDOM' button, and the display will show "rA XX 00" . Then the player will begin to random play the tracks.
2. Press the skip forward/backward button **⏮** can skip to the next track.
3. Directly press the number buttons to choose the corresponding track, but the random will not be cancel at the same time.
4. Press the 'CLEAR' button to cancel the random play.

3.7 Information Window

Adjust the Lightness of Alphanumeric Display

1. Press the button 'DIMMER' during stop or play to adjust the lightness of alphanumeric display window. The lightness will change as the following order:

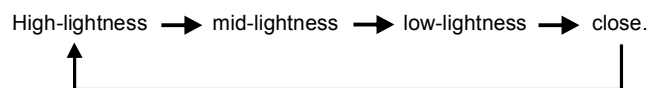

2. When restart the player, the lightness will be same as the last model.
3. The lightness model is set as high-lightness when the unit leaves factory.

3.8 Work hour display

When there is no disc laid, press "play+Next" at the same time, and it will display the total work hours for this unit.

4.1 Specification

Specifications

Analog Output:	2V RMS
S.N.R.:	≥95dB
T.H.D:	≤0.06%
Dynamic Range:	96dB
Frequency Response:	20Hz~20KHz
Digital Coaxial Output:	0.5Vp-p

General Specifications

Disc:	One Disc, 80mm or 120mm
Sample Rate:	44.1KHz
Digital Output:	Coaxial * 1
Power Consumption:	10W Max.
Temperature Range for Using:	+5°C~+35°C
Power Supply:	Specified on rear panel

Physical Specifications

Dimensions(W*H*D):	430mm*110mm*316mm
Net Weight:	5Kg



Chengdu Xindak Electronic Co.,LTD

No.126, Section 2, East 1 Round, CHENGDU, SICHUAN

Phone/Fax:+86(28)84711993

www.xindak.com



is a registered trademark of Chengdu Xindak Electronic Co.,LTD

© 2006 Chengdu Xindak Electronic Co.,LTD

